

Article number: 0106045

Description: Retaining ring JV 28

Measures

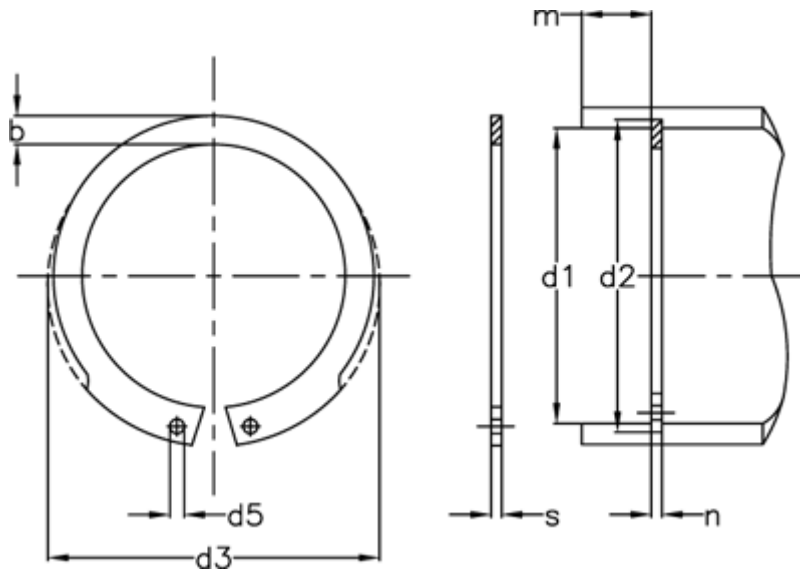

AN mm ²	= 31	FRg kN	= 5.2	tol	= 0.1
b	= 3.1	FR kN	= 15.3	tol	= -0.06
d1	= 28	g	= 1.0	tol	= +0,50-0,25
d2	= 29.4	K kN-mm	= 30.4	tol	= +0,21
d3	= 30.1	m min	= 1.30	Tong	= ZGJ-1
d5 min	= 1.5	Nominal drive	= 2.1	Weight kg/1000	= 1.80
Description	= JV 28	s	= 1.20		
FN kN	= 5.10	t	= 0.70		